

Potain MCT 50

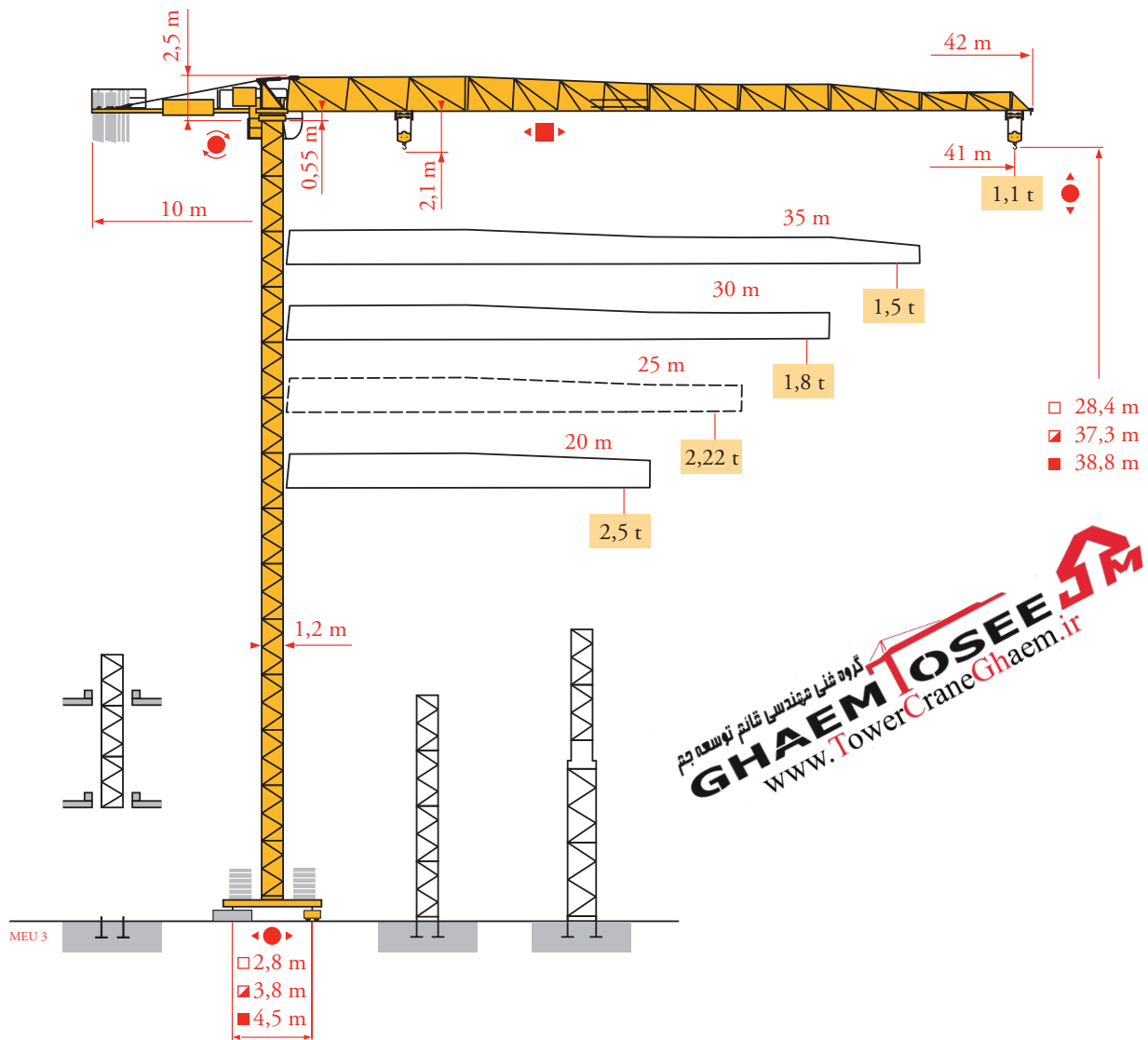

Mat / Réactions
 Maste / Eckdrücke
 Masts / Reactions
 Mástil / Reacciones
 Torre / Reazioni
 Tramo / Reações
 Композиции башни /
 Реакции

1,2 m
 20 m ⇒ 41 m

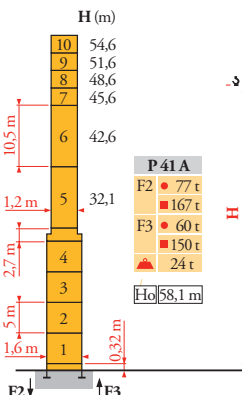
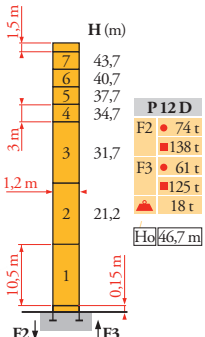
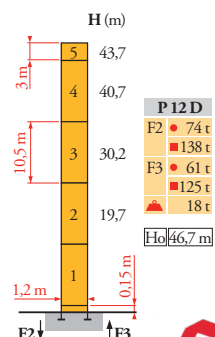
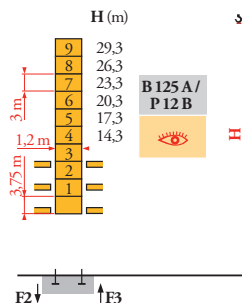
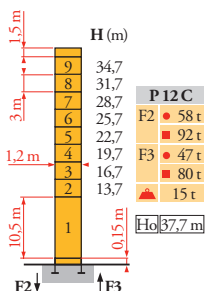
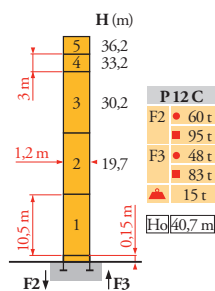

www.GHAEMTOSEE.com
 www.TowerCraneGhaem.ir

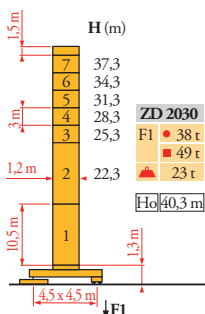
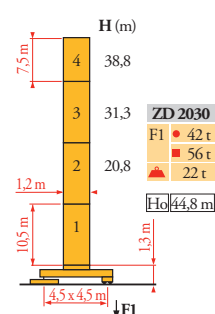
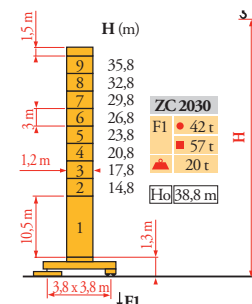
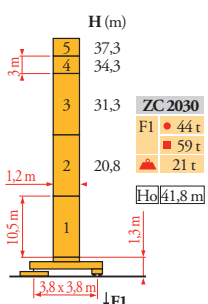
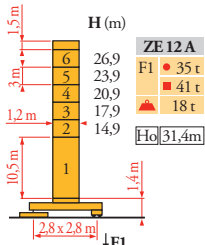
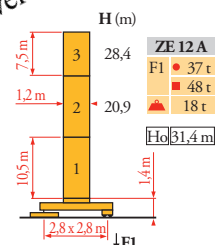

	ZE 12 A	ZC 2030 ZD 2030
2	 H2 = H + 0,15 m	H2 = H + 0,3 m
3	 H3 = H	H3 = H
4	 H4 = H	H4 = H + 0,2 m

- FR** ● Réactions en service ● Reaktionskräfte in Betrieb ● Reactions in service ● Reacciones en servicio ● Reazioni in servizio ● Reações em serviço ● Реакции при работе
- Réactions hors service ■ Reaktionskräfte außer Betrieb ■ Reactions out of service ■ Reacciones fuera de servicio ■ Reazioni fuori servizio ■ Reações fora de serviço ■ Реакции в покое
- A vide sans lest (ni train de transport) avec flèche et hauteur maximum Ohne Last, Ballast (und Transportachse), mit Maximalausleger und Maximalhöhe Without load, ballast (or transport axes), with maximum jib and maximum height Sin carga, sin lastre, (ni tren de transporte), flecha y altura máxima A vuoto, senza zavorra (ne assali di trasporto) con bracci massimo e altezza massima Sem carga (nem trem de transporte)- sem lastro com lança e altura máximas Вес без груза, балласта (или транспортных осей), с максимальной длиной стрелы и максимальной высотой
- Ho** H sans cabine H Ohne Fahrerhaus H without cab H sin cabina H senza cabina H sem cabine Высота без кабины

Courbes de charges
Lastkurven
Load diagrams
Curvas de cargas
Curve di carico
Curva de cargas
Диаграммы грузоподъемностей

MEU3

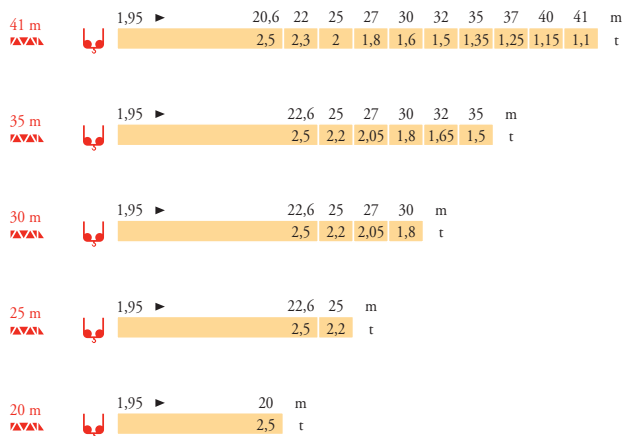

گروه غنی مهندسی قائم توسعه جنم
GHAEM TOSEE
 WWW.TowerCraneGhaem.ir

Télescopage sur dalles
Kletterkrane im Gebäude
Climbing crane
Telescopage gruas
trepadoras
Gru in cavedio
Telescopagem sobre lages
Кран, ползущий внутри здания

MEU4

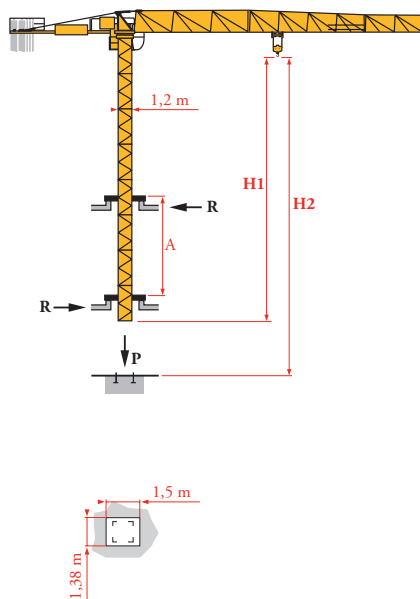



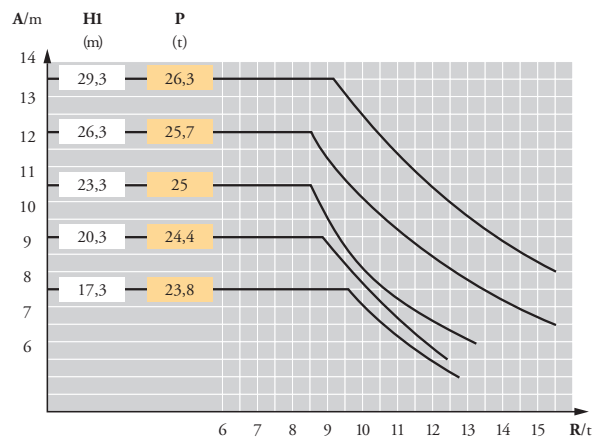





B 125 A



	FR	DE	EN	ES	IT	PT	RU
A	Distance entre cadres	Abstand zwischen den Rahmen	Distance between collars	Distancia entra marcos	Distanza fra i telai	Distância entre quadros	Расстояние между рамками крепления
H1	Hauteur grue	Kranhöhe	Crane height	Altura grúa	Altezza gru	Altura da grua	Высота крана
P	Poids de la grue(en service)	Krangewicht (in Betrieb)	Crane weight (in service)	Peso de la grúa (en servicio)	Peso della gru (in servizio)	Peso da grua (em serviço)	Вес крана (при работе)
R	Réaction horizontale	Horizontalkräfte	Horizontal reaction	Reaccion horizontal	Reazione orizzontale	Reacção horizontal	Горизонтальные реакции
	Voir télescopage sur dalles	Siehe Kletterkrane im Gebäude	See climbing crane	Vea grua trepadora	Consultare gru in cavedio	Ver telescopagem sobre lages	См. кран, ползущий внутри здания

Mécanismes
Antriebe
Mechanisms
Mecanismos
Meccanismi
Mecanismos
Механизмы

MEU 3

								ch - PS hp	kW			
	15 LVF 13 Optima	m/min τ	2,8 2,5	→ 7,6 → 2,5	→ 24 → 2,5	→ 42 → 1,4	→ 56 → 0,8	15	11	200 m		
	25 LVF 13 Optima	m/min τ	4,3 2,5	→ 11,4 → 2,5	→ 36 → 2,5	→ 57 → 1,45	→ 71 → 1,1	→ 86 → 0,62	25	18	225 m	
	RVF 51 Optima +	tr/min U/min - rpm	0 → 0,8						5,5	4		
	2 DVF 2	m/min	0 → 51						2	1,5		
	ZE 12 A TVD 324	m/min	26						2 x 4	2 x 2,9		
	ZC 2030 ZD 2030 RT 224	m/min	25						2 x 4	2 x 2,9		
		CEI 38										
		400 V (+6% -10%) 50 Hz						15 LVF : 25 kVA 25 LVF : 35 kVA				

15 LVF 13 Optima

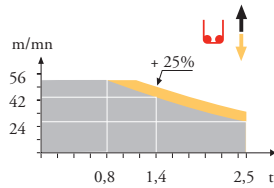

25 LVF 13 Optima

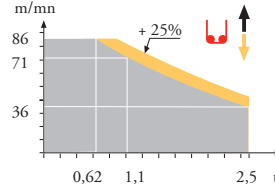

FR

Levage
Distribution
Orientation
Translation

DE

Heben
Katzfahren
Schwenken
Kranfahren

EN

Hoisting
Trolleying
Slewing
Travelling

ES

Elevación
Distribución
Orientación
Traslación

IT

Sollevamento
Distribuzione
Rotazione
Traslazione

PT

Elevação
Distribuição
Rotação
Translação

RU

Подъем
Перемещение каретки
Поворот
Перемещение крана

گروه غنی مهندسی قائم توسعه جم
GHAEM TOSEE
www.TowerCraneGhaem.ir



Document commercial non contractuel. Pour toute information technique se référer à la notice correspondante.

Unverbindliches Vertriebsdokument. Für technische Informationen, siehe die entsprechenden Anweisungen.

This commercial document is not legally binding. For any technical information, please refer to the corresponding instructions.

Documento commercial no contractual. Para cualquier información técnica, ver la noticia correspondiente.

Documento commerciale non vincolante, per tutte le informazioni tecniche fare riferimento al catalogo istruzioni.

Documento comercial não contractual. Para qualquer informação técnica complementar consultar as respectivas instruções.

Этот коммерческий документ не является юридически обязательным. Для получения технической информации, см. соответствующие инструкции.

دفتر تهران: خیابان پاسداران-خیابان شهید کلاهدوز (دولت) بین چهارراه قنات و کاوه
روبروی خیابان مطهری-شماره 276 واحد 1
تلفن: 021-22766747 نمابر: 021-22766748

نمایشگاه و انبار سلفچگان: 45 کیلومتر جاده قم دلچیان
منطقه ویژه ی اقتصادی سلفچگان

دفتر مرکزی و کارخانه: منطقه صنعتی دولت آباد-خرعی اول، جامی 2
قائم توسعه جم تلفن : 031-95024603-6 , 031-45836808
همراه : 0913 311 4603 رضایی

Manitowoc

Manitowoc - Americas - World Headquarters
2400 S. 44th Street • Manitowoc • WI 54220 USA
Tel: +1 920 684 4410 • Fax: +1 920 652 9778

Manitowoc - Europe, Middle East & Africa
Manitowoc France SAS
18, rue de Charbonnières B.P. 173 • 69132 ECULLY Cedex • FRANCE
Tel: +33 (0)4 72 18 20 20 • Fax: +33 (0)4 72 18 20 00

Manitowoc - Asia Pacific
16F Xu Hui Yuan Building,
1089 Zhongshan No.2 Road (S) • Shanghai 200030 China
Tel: +86 21 6457 0066 • Fax: +86 21 6457 4955